

Laguna

POWERFLO

SKIMMER FILTER (PT-1774)

FILTER FALLS (PT-1770)

5000

SKIMMER FILTER 5000
(PT-1774)

Installation and Maintenance Guide

READ THOROUGHLY BEFORE ATTEMPTING
INSTALLATION AND KEEP FOR
FUTURE REFERENCE

FILTER FALLS 5000
(PT-1770)



**TOOLS
REQUIRED:**

- Flathead Screwdriver
- Awl (punch tool)
- Shovels
- Sharp Knife
- Pliers or vise grips

INCLUDES:

Skimmer Filter:

- 1-1/2" Hose Connector
- 1-1/2" Hose Clamp
- Teflon Tape

Filter Falls:

- 1-1/2" Hose Connector
- 1-1/2" Hose Clamp
- Teflon Tape

Congratulations on your purchase of the Laguna Skimmer Filter and/or Laguna Filter Falls

As with all our pond products, Laguna Skimmer Filter and Filter Falls are designed to make your water gardening experience as simple and enjoyable as possible. Proper installation of these units will provide several benefits, including clear and healthy pond water, low maintenance, and, of course, a pleasant water garden environment for you and your family to enjoy and be proud of.

The Skimmer Filter and Filter Falls are designed to work together in ponds up to 10,000 US gallons (37,850 litres), but they can also work equally well independently in ponds up to 5000 US gallons (18,925 litres). Whether you install both or only one filter will depend on your water garden needs, including the size of your pond and the types of water features you desire.

Their ability to perform in large ponds, as well as their heavy-duty construction and multiple features, make these units well suited for use by professional contractors as well as pond hobbyists.

This manual will cover all aspects of starting a new pond, including choosing the proper location and shape of your pond, excavation, choosing and installing the right liner, installing the Skimmer Filter and/or Filter Falls in a new or existing pond, accessorizing your pond, and adding fish and plants. Read and understand these instructions thoroughly before beginning your pond project.

TABLE OF CONTENTS

QUICK INSTALLATION INSTRUCTIONS	3	EXAMPLES OF POND INSTALLATIONS	17 to 19
INSTALLING THE SKIMMER FILTER AND FILTER FALLS – NEW PONDS	5	ADDING POND ACCESSORIES	19
Plan ahead	5	Connecting a Laguna Fountain Pump to the Filter Falls	19
Deciding on where to install the Skimmer Filter and Filter Falls	5	Connecting a Laguna UV Sterilizer to the Filter Falls	19
Excavation	6	Installing pond lighting	19
How deep should your pond be?	6	ADDING PLANTS	20
Choosing the right liner and size	6	Oxygenating plants	20
Finishing your new pond's infrastructure	7	Floating plants	20
INSTALLING THE SKIMMER FILTER	8	Deep water plants	20
In an existing pond	8	Marginal plants	20
Where to place the Skimmer Filter	8	ADDING FISH	20
Marking the spot	8	LAGUNA WATER TREATMENTS	21
Excavating a hole for the Skimmer Filter in new and existing ponds	9	Water Prep	21
Installing the Skimmer Filter	9	Plant Grow	21
Gluing the liner on the Skimmer Filter	10	Clear Fast	21
Installing the faceplate	10	Bio Booster	21
Cutting the liner at the opening of the Skimmer Filter	11	BioSludge Control	21
Installing a pump	11	Phosphate Control	21
Installing the floating door	12	FEEDING FISH	22
Installing the basket and media	12	Laguna Goldfish and Koi food	22
Laguna filter media	13	Laguna Premium Goldfish and Koi food	22
INSTALLING THE FILTER FALLS	14	MAINTENANCE	23
Bulkhead fittings	14	WINTERIZING	23
Attaching the tubing to the Filter Falls output	14	Skimmer Filter	23
Connecting the Skimmer Filter to the Filter Falls	15	Filter Falls	23
Installing the drain plug	15	REPLACEMENT PARTS	23
Connecting 1-1/4" tubing to the Filter Falls	15	WARRANTY REGISTRATION CARD	23
Connecting 1-1/2" tubing to the Filter Falls	16		
Connecting 2 pumps to the Filter Falls	16		
Placing filter media inside the Filter Falls unit	16		



POWERFLO

SKIMMER FILTER AND FILTER FALLS

5000

QUICK INSTALLATION INSTRUCTIONS

EXCAVATING FOR THE SKIMMER FILTER

Dig an 18-inch deep hole in desired spot. Use soil or fine gravel to backfill and tamp down to a stable and level base 14 inches deep.



INSTALL THE SKIMMER FILTER

Place the unit in the hole, ensuring that the input faces the pond. Backfill, making sure that it is stable and level and the liner can be pulled over the top of unit. Top screw hole on front panel of unit should be level with water surface (when pond is filled later).



GLUE LINER ON THE SKIMMER FILTER

Tightly place the liner over the front face of the unit. Pull back liner exposing the front of the unit. Apply silicone glue around the opening (including around the screw holes). Press the liner against the unit, making sure there are no wrinkles.



INSTALL THE FACEPLATE

Punch a hole through the liner from inside the unit. Place the corresponding hole on the faceplate over the hole and fasten with a screw. Use a pair of vise grips or pliers to hold the nut in place while tightening screw to ensure a secure fit. Repeat for all holes.

Do not use power screwdriver to tighten screws and grip nuts with pliers when tightening screws to avoid stripping.



CUT THE LINER OVER OPENING OF THE SKIMMER FILTER

After the faceplate is installed, cut the liner covering the opening and seal with silicone.



INSTALL THE PUMP(S)

Place circulating pump(s) inside the chamber and run tubing to it through side opening. Attach a Click-Fit coupling to the tubing and connect it to the pump output. Run other end of the tubing to the desired pond equipment or to pond. Run pump power cord(s) out the top of the Skimmer Filter unit, positioning the cords in the slots provided.



INSTALL FLOATING DOOR, BASKETS AND MEDIA

Place the floating door and media baskets inside the unit. Install the coarse filter pad and Biospheres (included) and other media (not included) if desired. Put the lid on and lock it. If installing the Skimmer Filter only, fill the pond. Finish infrastructure work. When water is at desired level, connect the pump(s) to power supply.

INSTALL THE FILTER FALLS

If you have a waterfall, install the unit near this area. If using the supplied spillway to generate waterfalls, place the unit in the desired location.

Build a stable and level foundation and place the unit on top of it. Install the spray bar, filter brushes and media baskets.

INSTALL THE DRAIN PLUG AND BULKHEAD FITTINGS

Screw the drain plug in place. Screw the fittings in the holes at the front of the unit. If using the spillway, use the bulkhead fittings to secure it in place. Tighten all bulkhead fittings and use Teflon tape or silicone on all threaded plugs and connectors.

ATTACH TUBING TO THE FILTER FALLS OUTPUT

Attach up to four separate hoses to the output of the Filter Falls. Each hose can supply water to the pond or to pond equipment such as a UV Sterilizer.

CONNECT THE SKIMMER FILTER TO THE FILTER FALLS

If also installing a Filter Falls unit, run the tubing from the Skimmer Filter to the Filter Falls to supply water to it. Use either 1-1/4" or 1-1/2" tubing.

PLACE MEDIA INSIDE THE FILTER FALLS UNIT

Place the brushes on the bar inside the unit. Install the coarse filter pad and Biospheres (included) and other media (not included) if desired. Put the lid on the unit and lock it. Fill the pond and connect the pump(s) to the power supply for water circulation to begin.

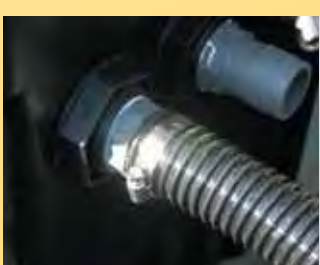

INSTALLING THE SKIMMER FILTER AND FILTER FALLS – NEW PONDS

Plan ahead

SELECTING A SITE

Before you pick up a shovel or a tape measure, a bit of planning will save time, money and mistakes. First of all, take a careful look at your own garden layout.

Selecting the right site for your pond is essential. Here are a few basic considerations:

LOOK FOR A SUNNY AREA.

Your water garden will need plenty of sunshine to support healthy fish and plants. However, a little shade can be advantageous. Look for the brighter areas in your garden but try to stay clear of heavily shaded, damp soggy corners. Ideally, select an area that gets 6 to 8 hours of sunlight.

VISIBILITY

Will you want to be able to see the pond from your house, deck or patio? The very nature of a pond makes it the focal point of your yard.

STAY AWAY FROM TREES.

Roots from trees may tear the pond liner. In addition, autumn leaves falling into your pond may clog filtering systems and have to be cleaned out daily. Shelter from the wind may prevent debris from getting blown into the water. A cedar hedge, for example, can be ideal.

MAKE SURE YOUR LOCATION IS CLEAR AND LEVEL.

While a sloping landscape does not completely rule out building a pond, you must remember that water will always find its own level. So planning your pond is extremely important. Ideal locations are those that are clear of roots, pipes and other obstacles, in an area that is relatively level.

ENSURE THAT THERE IS A WATER SUPPLY NEARBY.

Ponds may need topping up with water occasionally, especially with evaporation in the summer.

DO YOU HAVE A POWER SOURCE?

Easy access to electricity is important for connecting water pumps, pond lights and other electrical accessories. Ensure that the circuit you use has a GFCI (Ground Fault Circuit Interrupter) on it. Conduits can be run underground from your home or garage for this purpose.

THE SHAPE OF YOUR POND

Once you've found the right location, you need to decide on the shape of your pond. Use a rope or hose to outline different possible shapes.

DECIDING ON WHERE TO INSTALL THE SKIMMER FILTER AND FILTER FALLS

You will have to decide on where to place your Skimmer Filter and/or Filter Falls. The Skimmer Filter must be located at the edge of the pond, with the opening facing the water. Since water enters through the opening of the Skimmer Filter, it must be installed so that the water can enter inside the opening. For complete instructions on excavation and installation see the section beginning with *Excavating a Hole for the Skimmer Filter in New and Existing Ponds* on page 9.

The Filter Falls must be installed completely outside of the pond. If you have already built a waterfall, you can place it near this area. The Filter Falls can supply water to your existing waterfall as well as to other pond equipment. If you wish to create a new waterfall using the Filter Falls Unit, place it where you wish to have this water feature. For complete instructions on installation see *Installing the Filter Falls* on page 14.



Once you've determined the shape of your pond, which takes into consideration the installation of the Skimmer Filter and/or Filter Falls, use spray paint or cord to make an outline.

EXCAVATION

With the outline clearly marked, it's now time to dig the hole. As with all strenuous physical activity, take care not to overexert yourself. Ask friends and/or relatives for help. Rent heavy equipment if necessary.



TIP: Make sure to create a series of concentric shelves around the perimeter of the pond. The shelves will stabilize the pond liner as well as provide flat planting areas for aquatic plants.

When excavating, dig straight to the deepest point, removing the earth as you go and digging towards



the outside perimeter of the pond. This will reduce the number of times you measure and check levels of shelves or steps.

HOW DEEP SHOULD YOUR POND BE?

The depth of your pond depends on several different

factors, including the types of plants you want to have in the pond. Also, check with your local authority regarding any by-laws which may govern pond construction, particularly depth and fencing in.

Three feet is generally an ideal depth. The first shelf should be about 12" deep. The second shelf should be approximately another 12" deep. The third shelf should be another 12" deep, making the total depth about 36" deep.



Once the excavation is complete, add a layer of sand or geo-textile to protect the actual liner from direct contact with roots or rocks. Then, lay in the actual liner.

CHOOSING THE RIGHT LINER AND SIZE

For best results, use Laguna Durashield Pond Liner, which is made of 45-mil, EPDM fish-grade synthetic rubber. The liner is flexible enough to conform to all the curves and shelves of the pond yet durable enough to last a long time. It's also non-toxic and safe for fish and plant life.

When figuring out the size of the liner required, first determine the maximum length and width of your pond. Then determine the depth. Double the depth and add this figure to the length and width. Then add an extra two feet for pond edges. This will give you the required size.

For example, if your pond is 20 ft long x 30 ft wide x 3 ft deep, you will need a liner that is 28 ft x 38 ft.

$$20 \text{ ft} + (3 \text{ ft} \times 2) + 2 \text{ ft} = 28 \text{ ft}$$
$$30 \text{ ft} + (3 \text{ ft} \times 2) + 2 \text{ ft} = 38 \text{ ft}$$

Once you have the right size liner, place it in the excavated hole and then proceed to make it conform with the shape and contours of the pond. Stretch and flatten it out as much as possible, getting rid of any large wrinkles or folds in the liner.



IMPORTANT: If you have dug a hole for the installation of a Skimmer Filter, remember that the liner should be placed only over the pond area which will contain the water and must not extend inside the hole for the Skimmer Filter.

After placing the liner, backfill any spaces between it and the hole with sand or excavated earth making sure it is clear of stones and debris.

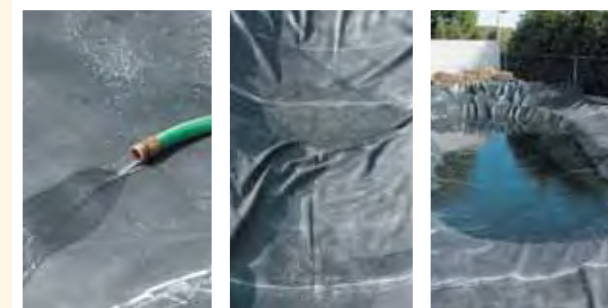

Add some water so that the liner settles into place. It is impossible to eliminate all wrinkles so let the weight of the water form the natural flow of the liner while trying to keep the wrinkles to a minimum.



Lay patio stones or slate around the perimeter of the pond. This will hold the liner in place and simultaneously create a natural touch. Use mortar to keep these decorative pieces in place. Cut any excess liner off from around the edges of the paving slabs.



FINISHING YOUR NEW POND'S INFRASTRUCTURE

If you build a waterfall, ensure that the base is solid. Fill any gaps or crevices with sand or soil. Make sure that the upper levels overlap to get a smooth water flow. Don't worry about any artificial appearance. As your pond ages and matures things will look more natural.



Planning ahead will help you determine if you want flowers or ornamental shrubs planted around or alongside your waterfall. The addition of lighting and ornaments can also have a striking effect on the visual effect of your pond.



INSTALLING THE SKIMMER FILTER IN AN EXISTING POND

Before you begin, you must drain the existing pond so that the water level drops at least 2 feet (or well below the depth of the Skimmer Filter). If you have fish and plants in the pond, take extra precautions to ensure their safety.

WHERE TO PLACE THE SKIMMER FILTER

Choose a spot which is within clear and easy access for maintenance. Place the Skimmer Filter in the desired spot, with the input opening facing the pond. Visualize and assess whether this is indeed the desired location.

MARKING THE SPOT

Once you have determined the desired location, mark the perimeter of the unit using a marker or spray paint. The outlined area marks the spot where you will need to excavate.



TIP: To get a precise marking do the following: take the lid off, place it on the desired spot, and mark the outline of the lid's perimeter. This will give you the accurate size of the unit.

If the marked area includes patio stones or rock slabs, remove them and proceed to cut them using the appropriate cutting tools. If you are not equipped with the right cutting tools, have a qualified person do it for you. After you have cut the stones or slabs, set them aside for now.



EXCAVATING A HOLE FOR THE SKIMMER FILTER IN NEW AND EXISTING PONDS

Dig a hole 18 inches deep in the designated area. Dig a little more than required around the sides of the Skimmer Filter to allow a little wiggle room (about 2 nice size stones worth). Keep the soil for backfilling. Once you've finished digging, test fit the unit. The top left screw hole on the front panel of the unit should be at the same level as the water surface or up to 1 inch above the water level (when the pond is refilled later).



IMPORTANT: Pull back the liner to ensure that it does not get ripped during excavation. Enlist the help of an assistant to hold the liner while you dig.

INSTALLING THE SKIMMER FILTER

Place the unit in the hole, ensuring that the input opening of the Skimmer Filter faces the pond. Ensure the unit is level. Using the previously dug up soil, backfill around the unit, making sure that it is stable and level.



Use soil or fine gravel (3 to 5 mm) to backfill. Regularly test fit the unit to ensure it remains level. Also, ensure that the liner can be pulled over the top of the unit. Tamp down the backfilling to achieve a level and stable foundation. The final depth should be 14 inches deep.



IMPORTANT: Do not overpack the backfilling around the sides of the unit to ensure that the unit remains square in the hole (i.e. the corner angles remain at 90 degrees). This will ensure that you can easily put the lid on the unit. Place rocks to fill the gaps on either side of the unit. Do not block the front input opening.





TIP: To check if the unit is level, fill it with water up to the first ridge inside the perimeter of the unit. The unit is level if the water level is equal all around.



NOTE: Make sure that the plug at the bottom of the Skimmer Filter is properly installed. This is especially important if you plan to use a bottom drain.

GLUING THE LINER ON THE SKIMMER FILTER

Place the liner over the front face of the unit. Ensure that it covers the front panel of the Skimmer Filter



tightly and completely. If necessary, use a stone to keep the liner tight. Leave lots of slack in the liner on either side of the unit. If all is okay, fold the liner away from the unit. Apply silicone glue around the perimeter of the Filter Skimmer's opening. Place the

liner back over the unit and press against it to ensure that it adheres completely to the unit.



DO NOT CUT THE LINER THAT COVERS THE INPUT OPENING OF THE UNIT YET.

INSTALLING THE FACEPLATE

The faceplate is installed around the perimeter of the input opening of the Skimmer Filter. There are ten holes along the perimeter of the faceplate which correspond to ten holes around the opening of the Skimmer Filter. Using an awl (a punch tool), punch through one of the holes from inside the unit. Place the corresponding hole of the faceplate over the punched hole and install a screw and nut using a flathead screwdriver. Leave the screw loose to allow you to align the rest of the screw holes. Repeat this process for all remaining screws. Tighten all screws.

NOTE: Do not use power screwdriver to tighten screws and grip nuts with pliers when tightening screws to avoid stripping.



CUTTING THE LINER AT THE OPENING OF THE SKIMMER FILTER

Once the faceplate is properly installed and you are satisfied with the results, it is now time to carve out that portion of the liner that covers the input opening of the Skimmer Filter. Using a sharp knife, cut the liner around the perimeter of the opening. Seal the cut liner inside the input opening with silicone. Trim off any excess liner above the Skimmer Filter opening and seal with silicone. Wipe off any excess silicone.



INSTALLING A PUMP

TIP: Choosing the right size pump depends on many factors, such as how much water is in the pond and how much work you are asking it to do. Will it circulate water only or will it pump water to a Filter Falls, UV sterilizer, waterfall, fountain head, and/or ornament? Answering these questions will determine the size of your pump. The more features you add, the more work you are asking your pump to do, and therefore, the more powerful it has to be. It's a good idea to buy one with a capacity slightly greater than your initial needs, especially since you may want to add to your system later.



Laguna has two Skimmer Filter Pumps available

MODEL	MAX. FLOW RATE	POND SIZE
2150 (PT-431)	2142 U.S. GPH 8100 LPH	Up to 4300 U.S. Gal. 16277 L
2905 (PT-436)	2905 U.S. GPH 11000 LPH	Up to 6000 U.S. Gal. 22712 L

TIP: Ensure that the length of tubing that you will connect to the pump output is long enough to perform the desired task, whether to circulate water to a connecting Filter Falls unit, or back into the pond, or to another piece of pond equipment. Use 1-1/4" or 1-1/2" diameter tubing. The Filter Falls unit comes with 1-1/4" and 1-1/2" input connectors.

Place the appropriate circulating pump inside the pump chamber and run the electrical cord through one of the



channels located at the back of the Skimmer Filter. Run the tubing inside the chamber through the side opening of the Skimmer Filter, attach a Click-Fit coupling to the tubing and connect it to the output of the pump. If necessary, use hose clamps. Run the other end of the tubing to the appropriate pond



equipment. The pump chamber is sufficiently large enough to hold two pumps if desired. Simply run the tubing through the side opening of the unit and the electrical cord through the channel located at the back of the unit.

TIP: Use *Laguna Silicone Lubricant* to make hosing connections easier.

INSTALLING THE FLOATING DOOR

Fill the door with sand. This will weigh it down and ensure that it sits properly in the unit. Place the door in the unit. The fish guard feature (or hump) on the



door should be just above to water level, not below it. The fish guard prevents pond fish from being sucked into the unit. You can adjust the buoyancy of the door by adjusting the quantity of sand inside.

INSTALLING THE BASKETS AND MEDIA

Place the media baskets inside the appropriate sections as illustrated. The baskets serve as holding areas for filter media. Mechanical media pads are typically placed first against the incoming water, beginning with a coarse pad, (included), followed by a medium pad, then by a fine pad (medium and fine pads not included). Biological media, such as Laguna Biospheres (included), are placed behind the mechanical pads.



After you have installed the media, put the lid on the unit. Make sure that the lid lock is in the "unlocked" position. Once the lid is properly closed, turn the lid locks to the "locked" position. If you want to place padlocks on the unit there are holes on the lid for this purpose. If you are

installing the Skimmer Filter only, you can now begin to fill your pond. Finish off any remaining infrastructure work, such as putting back the patio stones or slabs. Once the water level has reached the desired level, connect the pump(s) to the power supply for water circulation to begin.



LAGUNA FILTER MEDIA

MECHANICAL/BIOLOGICAL



Coarse Mechanical/ Biological Filter Pad (PT-1775)
For large particulate waste
Included

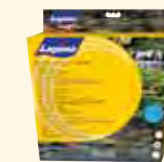

Medium Mechanical/Biological Filter Pad (PT-1776)
For medium particulate waste
Sold separately

BIOLOGICAL



Biospheres (PT-1785)
Included



BioMax (PT-560)
Sold separately

MECHANICAL



Fine Water Polishing Filter Pad (PT-1777)
For fine particulate waste
Sold separately



BioMesh (PT-1779)
For fine particulate waste
Sold separately



Filter Wool (PT-1780)
For fine particulate waste
Sold separately

BIOLOGICAL/CHEMICAL



Barley Straw (PT-575)
Sold separately

CHEMICAL



Peat Granules (PT-574)
Sold separately

INSTALLING THE FILTER FALLS

Choose the appropriate location for the Filter Falls. If you have already built a waterfall, install the unit near this area, as the output tubing will supply the



water to the existing waterfall. If you intend to use the supplied spillway to generate your waterfalls, place the unit in the desired location. Build a stable and level foundation. Use cinder blocks, for example. Make sure that the foundation is high enough to allow proper drainage.



Place the Filter Falls unit on top of the foundation, making sure that it is level and will drain properly. Check that the unit is square and that the lid will close properly. Ensure that the spray bar, filter brushes and media baskets are correctly placed.

BULKHEAD FITTINGS

Apply Teflon tape on the four supplied bulkhead fittings, then screw them into the bulkhead holes located at the front of the Filter Falls unit.

Apply Teflon tape on the threaded areas of each of the four supplied hose adapters, then screw each one into the bulkhead fittings.



IMPORTANT: Avoid cross-threading the adapters when screwing them into the bulkhead fittings.



If you are installing the spillway, use the bulkhead fittings to secure it in place.

ATTACHING THE TUBING TO THE FILTER FALLS OUTPUT

You can attach up to four separate hoses to the output of the Filter Falls. Each one can transport water from the Filter Falls to the pond or other pond equipment such as a UV Sterilizer. Ensure that each hose is long enough to do the required task. Place a 1-1/16" to 2" hose clamp (PT-1354 not supplied) at the end of the tubing. Fit the tubing over



the grey hose adapters in a twisting motion. If necessary, lubricate with Laguna Silicone Lubricant (sold separately). Tighten the hose clamps securely. Do the same for the other tubing if required.

CONNECTING THE SKIMMER FILTER TO THE FILTER FALLS

The pump or pumps inside the Skimmer Filter draws the water from the pond. Water flows through the filter, passing through the filter media. If you choose to install a Filter Falls unit, you must run the tubing from the Skimmer Filter to the Filter Falls in order to supply water to it. Once you have determined the path of the tubing, you may want to dig a shallow trench in which to lay and bury it, if necessary.

INSTALLING THE DRAIN PLUG

The drain plug allows for easy and convenient water drainage. Apply teflon tape on the threaded area of the supplied drain plug and screw it into place. Remove the plug to drain the water. Ensure that the drain plug is unobstructed.



If you choose to install the Filter Falls in ground, install a 1-1/2" male adapter (not included) in the drain hole, attach non-king tubing and extend it horizontally to an above-ground location, then attach a valve at the end of the tubing. The hosing must be installed so that it drains downward.

CONNECTING 1-1/4" TUBING TO THE FILTER FALLS

If using 1-1/4" tubing, you can connect it to the Filter Falls using the supplied 1-1/4" venturi valve connector. This connector has a venturi valve that mixes air with water for added oxygenation.

To install, apply Teflon tape on the threaded area of the connector, then screw it into the side opening. Seal the



opening at the other end of the unit with the supplied cap. Attach the tubing coming from the pump (inside the Skimmer Filter or pond) to the connector.

CONNECTING 1-1/2" TUBING TO THE FILTER FALLS

If using 1-1/2" tubing, you can connect it to the Filter Falls using a 1-1/2" connector. Follow the same procedure as above.



TIP: In certain situations, it may be advantageous to run the tubing from the bottom up along the side of the unit. In this situation, use an elbow connector (sold separately) to connect the tubing to the Filter Falls.

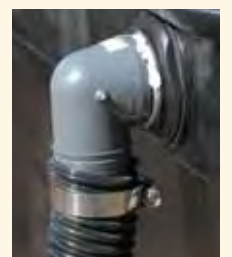

CONNECTING TWO PUMPS TO THE FILTER FALLS USING 1-1/4" AND 1-1/2" TUBING

Tubing from two pumps can be connected to the Filter Falls, one at each end, using the appropriately sized connectors. In this scenario, you must modify the spray bar as follows to get the best results:

Remove the spray bar and cut it to get two 4 inch pieces. Place the pieces back into the input openings, with any remaining holes in the bar pointing down. Attach two elbows (sold separately) to the ends of the spray bar so that the water flows downward into the unit.

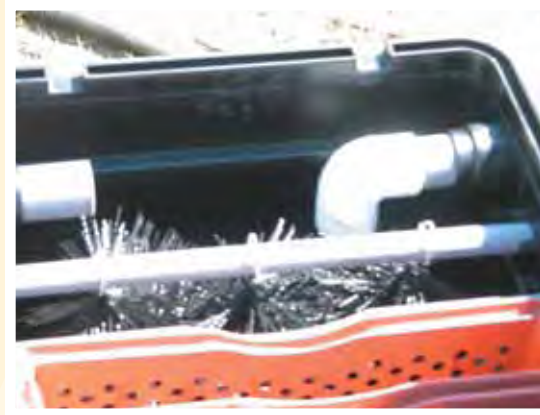

PLACING FILTER MEDIA INSIDE THE FILTER FALLS UNIT

As with the Skimmer Filter, the Filter Falls includes baskets that serve as holding areas for the filter media, plus a chamber for filter brushes (included). Hang the brushes on the bar and install it inside the unit at the back end.



The unit includes a Coarse Mechanical Filter Pad, which is typically placed first against the incoming water. Biospheres, also included, perform biological filtration and should be placed after all mechanical media. See *Laguna Filter Media* on page 13 for more information about filter media.

TIP: *If installing both the Skimmer Filter and Filter Falls, you can configure the Skimmer Filter to perform mechanical filtration and the Filter Falls biological and chemical filtration.*



After you have installed the media, put the lid on the unit. Make sure that the lock is in the "unlocked" position. Once the lid is properly closed, turn the lid locks in the "locked" position. If you want to place padlocks on the unit there are holes on the lid for this purpose.



After everything is properly installed, fill the pond with water, and connect the pump(s) to the power supply for water circulation to begin.

EXAMPLES OF POND INSTALLATIONS WITH SUGGESTED EQUIPMENT

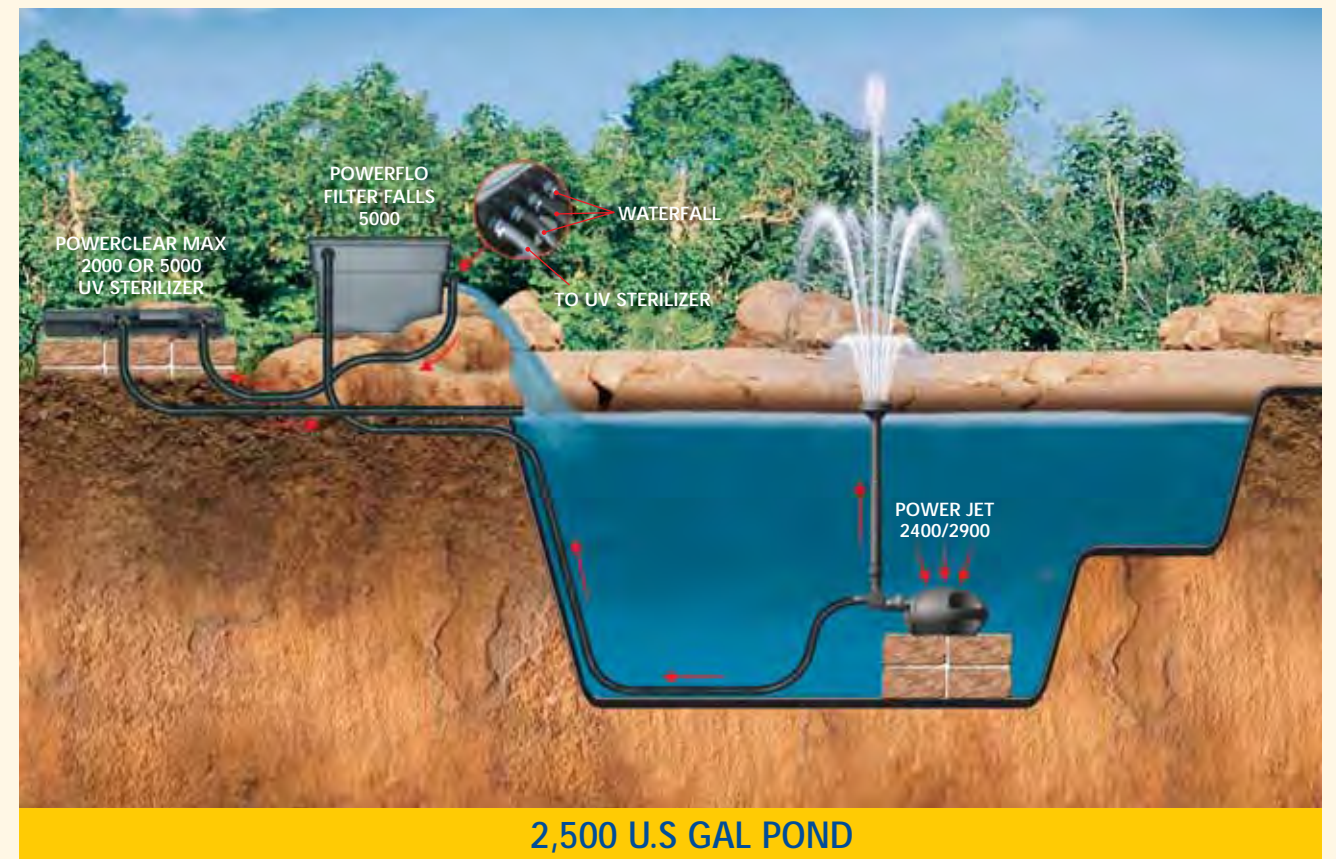
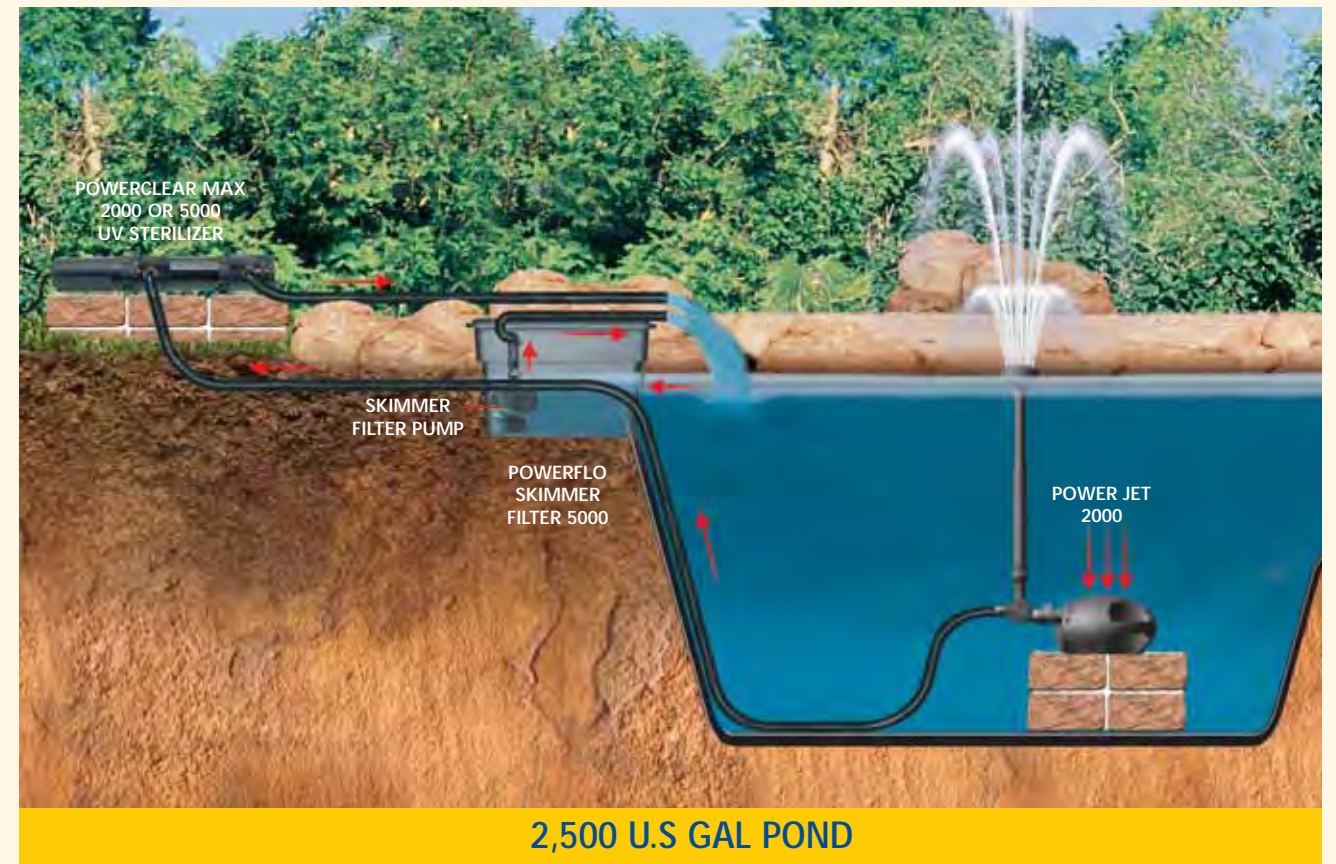

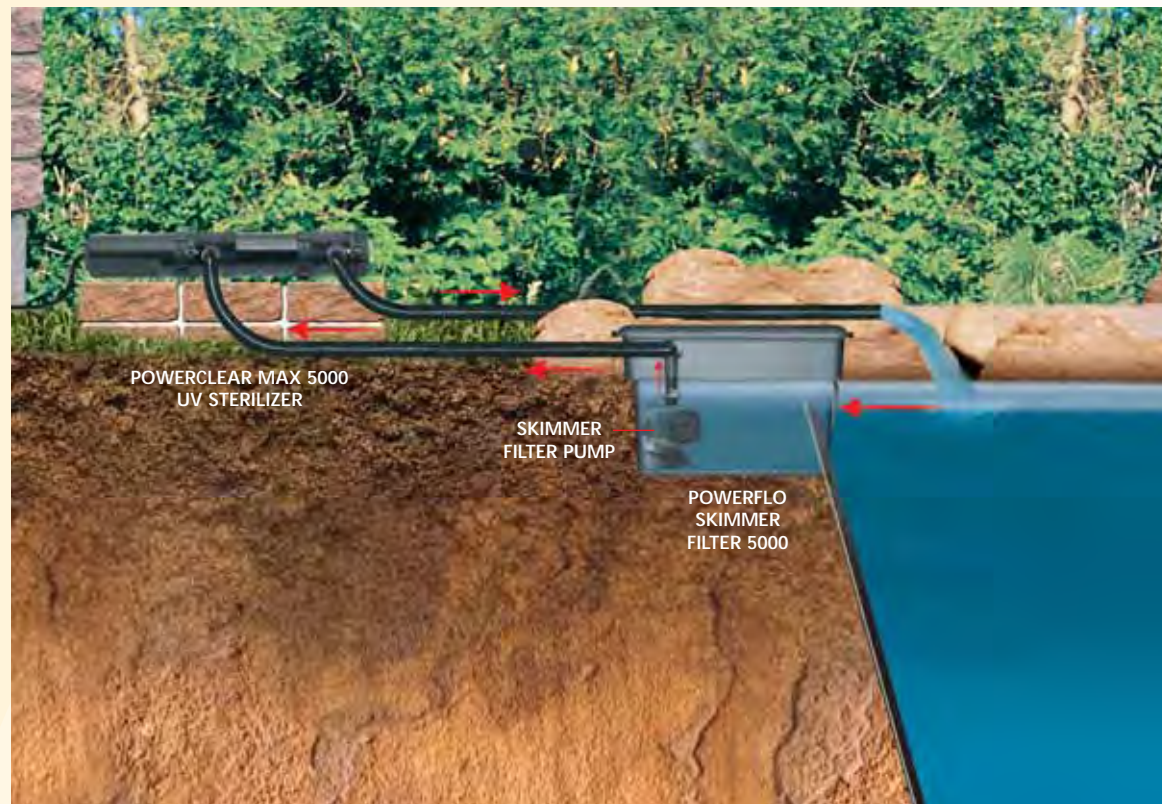

5,000 U.S. GAL POND

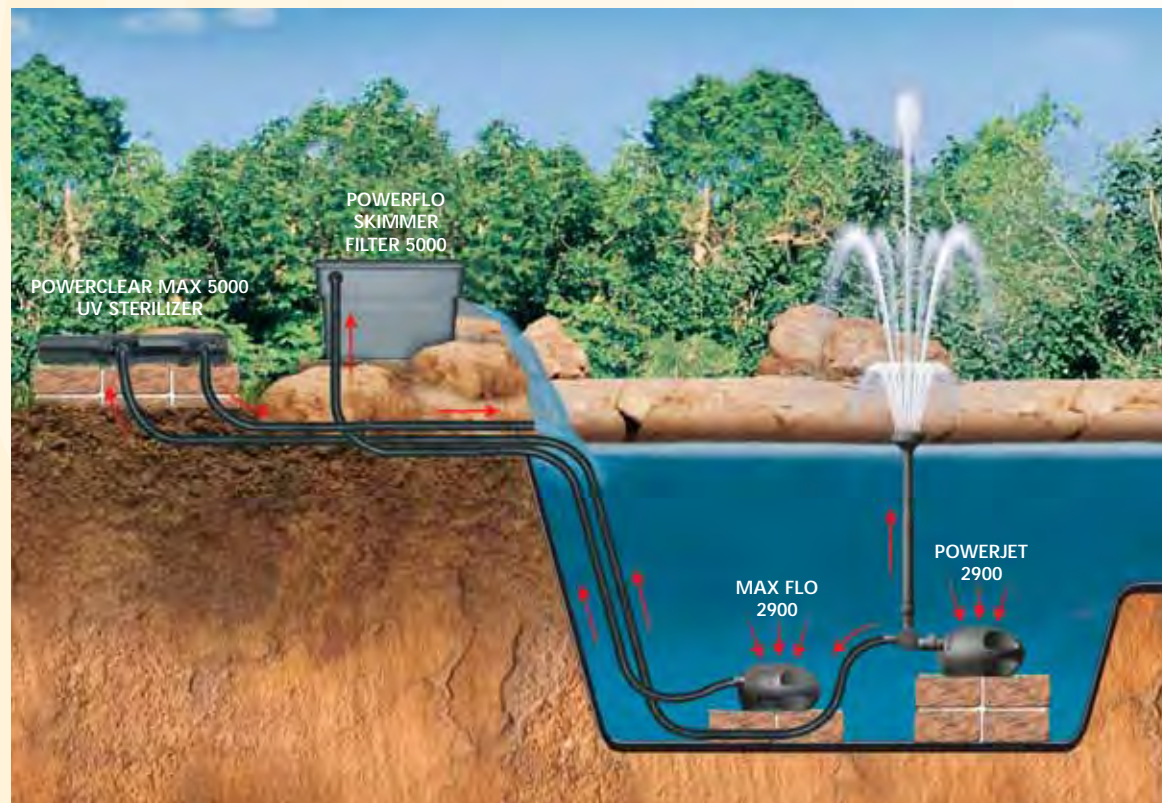

5,000 U.S. GAL POND

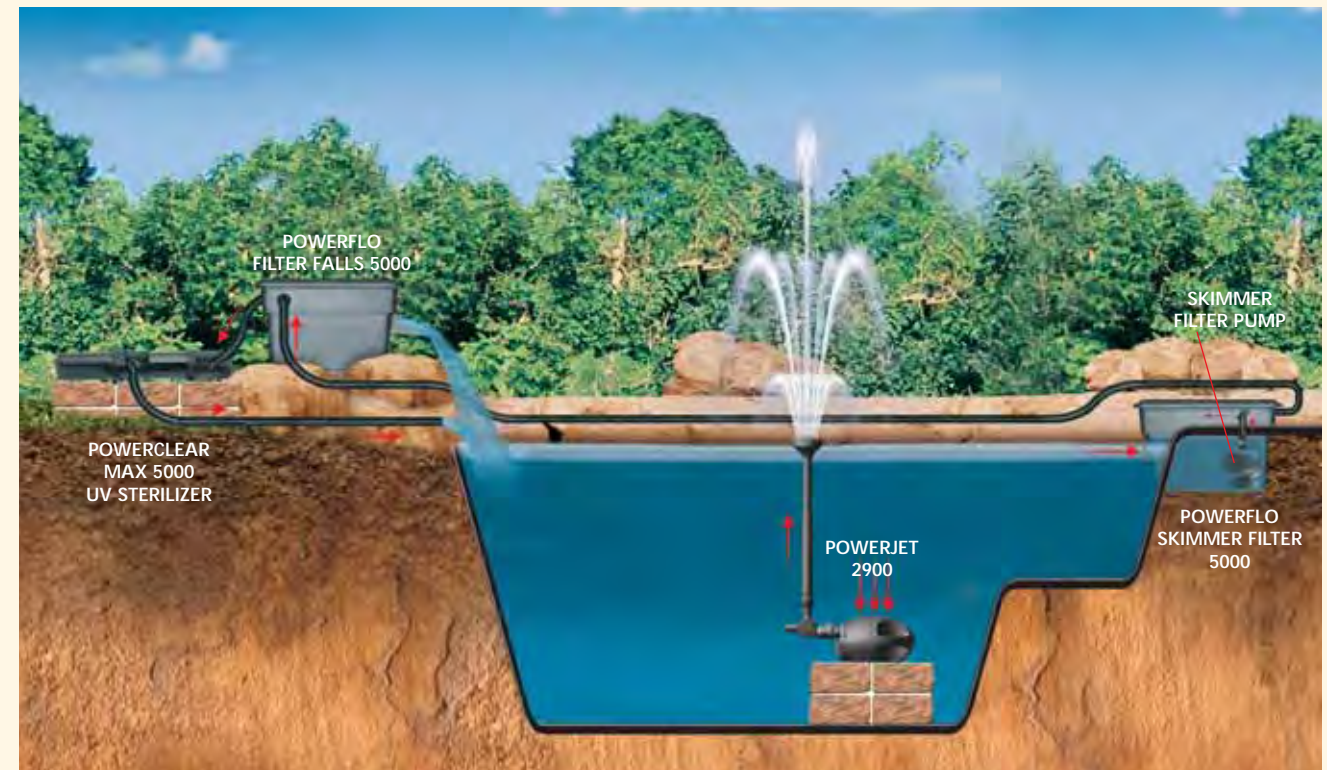

10,000 U.S. GAL POND

CAUTION: Always unplug all appliances in the pond from the electrical power source before installing, repairing, maintaining or handling pond equipment.

CONNECTING A LAGUNA FOUNTAIN PUMP (sold separately) TO THE FILTER FALLS

If installing the Filter Falls unit only, you will need to also install one or more pumps in order to create the required water circulation. There are many different ways of doing this. Here is one recommended configuration. Ask your Laguna dealer for the best solution suited for your situation.

Place a Laguna Max-Flo Pump in the pond and anchor it to a stable and level base. Put a Click-fit coupling at the end of the tubing (sold separately) and connect it to the output of the pump. If necessary, use Laguna Silicone Lubricant and hose clamps. Run the tubing to the Filter Falls unit and make the proper connections on the side input. Connect the pump to the power supply to begin water circulation.

CONNECTING A LAGUNA UV STERILIZER (sold separately) TO THE FILTER FALLS

A UV Sterilizer is instrumental in keeping unwanted floating algae in check. Algae proliferation compromises the clarity of your water and diminishes the overall beauty of your pond. In this configuration, a Laguna PowerJet Pump with fountain head is used to provide the water flow to the UV unit as well as to create a fountain display.

Unplug the pump(s) supplying water to the Filter Falls, if applicable. Place the UV Sterilizer in a secure area. The unit

can be placed on cinder blocks or on a slab, for example. If necessary, there are mounting brackets to anchor it in place. Route the electrical cord from the UV unit to the transformer (included with the UV Sterilizer). Mount the transformer to an elevated area. Follow all safety precautions and instructions indicated in the UV Sterilizer Installation and Maintenance Guide.

Place an assembled PowerJet Pump in the pond and anchor it to a stable and level base at the desired height. Put a Click-fit coupling at the end of the tubing and connect it to the output of the pump. Run the tubing to the UV Sterilizer. Place the click-fit connector at the end of the tubing, then attach it to the input of the UV unit. (The UV Sterilizer includes two Universal Click-Fit couplings, which can be cut to the desired diameter of the tubing). Connect another tubing to the other end of the UV unit, using the other supplied Click-Fit connector. If necessary, use Laguna Silicone Lubricant and hose clamps. Rotate the UV unit in the desired position. Run the tubing from the output of the UV unit to the Filter Falls and make the proper connections on the side input. Connect the pump to the power supply to begin water circulation.

INSTALLING POND LIGHTING

The addition of underwater lighting can make a pond come alive at night. You should have already planned for this and have the extra electrical circuit nearby. Experiment with the direction and colour of your lighting until the desired look or mood is achieved.

ADDING PLANTS

The addition of plants to your pond will really add to its natural look. However, care should be taken when selecting and placing plants in and around the pond. There are four categories of pond plants.

OXYGENATING PLANTS

These plants use fish waste as fertilizer and provide oxygen to the water. They also help keep a natural balance by competing with algae for minerals and thereby limiting the growth of algae. These plants may not be able to provide all of the oxygen necessary for your pond's livestock and so help may be needed from a fountain or waterfall.

FLOATING PLANTS

Floating plants should cover 60 to 70 percent of the pond's surface area. This will inhibit algae development and provide important shade, which will in turn help plants like water lilies until they mature and have leaves large enough to take over this role.



Depending on the type of floaters you have, it is important to wait until the risk of frost is over before introducing them to your pond.

DEEP WATER PLANTS

Plants, like water lilies, provide decoration, flowers and shade for fish and other inhabitants of the pond.

MARGINAL PLANTS

The heart of natural filtration, these plants are placed in planting pots and submerged on pond shelves so that water covers the pots by a couple of inches. These plants give a natural, soft appearance to your pond.

Avoid placing most plants directly in the path of the water flow as this may inhibit their growth.

WATER MAINTENANCE: LAGUNA WATER TREATMENTS

As your pond ages you will need to deal with a number of challenges, which Laguna Pond Treatments will help overcome using two distinct approaches. Whenever possible, a biological approach is recommended since it provides beneficial strains of naturally-occurring bacteria. Regular use improves water conditions by establishing significant populations of beneficial bacteria that control water impurities, toxins, and waste. The second approach is to use the safest possible treatment for things like detoxifying tap water before it causes stress to fish, clarifying water quickly, or supplementing pond plants.



WATER PREP

Water quality must be ideal in order to sustain life. Most municipalities add chemicals such as chlorine and chloramine to water. These are highly toxic to fish and must be removed. Often other contaminants such as metals are also present. Water Prep eliminates harmful chlorine or chloramine from newly added tap water, immediately making pond water safe for inhabitants. It also neutralizes toxic metal ions found in tap water before they can harm fish. In addition, it provides a protective coating on fish that may have been scraped off due to netting or transport. Use it whenever new water is added to your pond.

PLANT GROW

You will want to ensure that your pond plants thrive. Plant Grow has a balanced blend of the right nutrients to promote growth and color. It will not add any phosphate or nitrate which could promote algae growth.

CLEAR FAST

When your pond water gets cloudy or turns green it should be clarified immediately. Clear Fast may be safely used in any fish pond. It is a fast-acting coagulant that bonds with suspended particles, making them heavy enough to be removed by filtration or fall to the bottom of the pond.

BIO BOOSTER

Bio Booster is a biological solution that efficiently removes ammonia and nitrite, which are liquefied toxins that adversely effect the health of fish and plant life. Ammonia and Nitrite are natural by-products of respiration and waste decay. Lethal concentrations can build up rapidly early in the life of a pond. Bio Booster maintains proper populations of necessary micro-organisms for peak water conditions. It purifies and naturally improves your pond ecosystem. Using it regularly speeds its efficiency and keeps water at optimal quality.

BIO SLUDGE CONTROL

Pond filter systems can rarely capture everything. It is normal for waste to collect at the bottom of your pond where it slowly breaks down and uses valuable oxygen, which is undesirable for maintaining optimal water. Bio Sludge Control incorporates a powerful team of nature's cleaners to solubilize and reduce accumulating solid waste. It also contains beneficial bacteria that work continuously to make the entire pond system work more efficiently. It also helps maintain your filter media and keep your water at its peak.

PHOSPHATE CONTROL

Phosphate Control naturally improves pond water clarity and overall pond conditions. Phosphate is a major nutrient that can stimulate undesirable pond conditions that result in unclear water. Micro-organisms in Phosphate Control's super-concentrated formula reduce phosphate levels. Phosphate Control contains a combination of powerful bacterial teams found in nature that improve water conditions for pond inhabitants.

ADDING FISH

Limit the initial number of fish you stock as they produce a lot of waste, which is potentially toxic to them. It is better to have too few than too many. Fish will often reproduce and grow quickly.

Treat them with care. Any handling or transportation, even introducing them to your pond, can create life-threatening stress. Handling them should be minimal. Always use a soft net.

Introduce them to the pond slowly, matching the water temperature by floating the bag in the pond before release. You can also add a little pond water into the bag to help them get used to differences in water quality. Add pond water to the bag 2 or 3 times during a 20 minute period. After 20 minutes of this introduction, you can release them into their new home.



FEEDING FISH

LAGUNA GOLDFISH & KOI FOOD

This advanced quality floating fish food formulated to provide superior nutrition while reducing organic waste. It is made with only the highest quality ingredients and contains no corn or corn starches.

The complete and balanced formulation includes multi-vitamins and stabilized vitamin C which help improve disease resistance and the health and longevity of fish.

The highly palatable food is always a favorite among pond fish, who go into a feeding frenzy when Laguna is on the menu. Goldfish & Koi Food is scientifically formulated to meet the nutritional requirements of all cold water fish and it will not cloud water. Small, medium, & large pellets, as well as sticks are available.



LAGUNA PREMIUM KOI & GOLDFISH FOOD

This food contributes to many excellent health benefits. The unique formulation, which includes superior ingredients such as wheat germ, kelp, spirulina, white fish meal, krill, multi-vitamins and stabilized vitamin C, promotes brilliant colors and lustrous appearance, as well as higher resistance to disease and better growth.

The exclusive formula also contains special enzymes that improve the digestion and absorption of vital nutrients. The highly palatable & digestible food creates less waste and results in cleaner, healthier pond water. The floating food sticks are specially formulated to soften quickly while maintaining their shape, allowing fish of all sizes to feed. Even the smallest fish can bite off small portions.

There are three varieties available Staple Diet, Spirulina & Wheat Germ, and Color Enhancing Formula.



Now that you have built, equipped, treated and stocked your pond, sit back, relax and enjoy.

MAINTENANCE

During the pond season, filter media baskets and mechanical filter media can easily be removed and rinsed with a garden hose as required to remove any dirt and debris. Biological media should be rinsed off with pond water periodically if there's an accumulation of sediments.

WINTERIZING (after the pond season is over)

SKIMMER FILTER 5000 (PT-1774):

Drain the pond to below the level of the input opening of the unit. Drain the water from the unit. Drain the water from the floating door, if necessary. Remove and rinse off all filter media and store indoors. Clean the media baskets. Remove the pump(s) from the unit, clean as per manufacturer's instructions, and store the pump(s) indoors. Ensure that the tubing is free of water and debris. Cover the opening with

specially designed rubber door (sold separately). Ensure that the lid is locked securely on the unit.

FILTER FALLS 5000 (PT-1770):

Drain the water from the unit. Remove and rinse off filter media and filter brushes and store them indoors. Rinse off media baskets. Ensure that the tubing is free of water and debris. Ensure that the lid is locked securely on the unit.

REPLACEMENT PARTS

ITEM	PART NUMBER
1. Media Basket:	PT-1782
2. Leaf Skimmer Basket:	PT-1789
3. Lock Pivot and Screw:	PT-1791
4. Bulkhead Fitting:	PT-1793
5. Male Adapter:	PT-1794
6. Drain Plug:	PT-1795
7. Female Adapter:	PT-1796
8. Rubber Door:	PT-1797
9. Stainless Steel Liner Mounting Screws:	PT-1799
10. Skimmer Float Door:	PT-1800
11. Bulkhead Plug:	PT-1802
12. Skimmer Float Cap:	PT-1804
13. Venturi Valve:	PT-1805
14. Pre-Filter Brush:	PT-1806

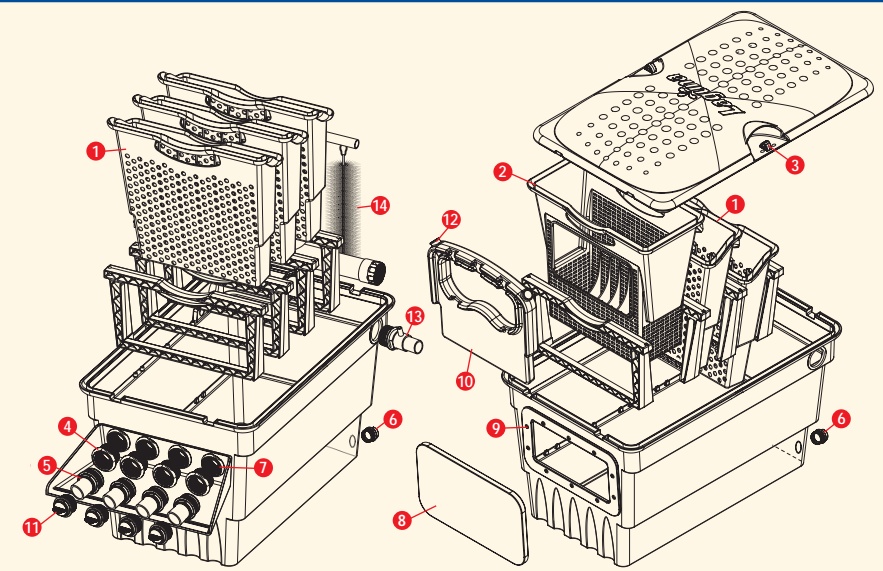

FILTER FALLS 5000 (PT-1770)

SKIMMER FILTER 5000 (PT-1774)

WARRANTY REGISTRATION CARD

RETURN TO VALIDATE YOUR GUARANTEE

Mr. Mrs. Miss Ms (PLEASE PRINT)

NAME _____
First Name Last Name

ADDRESS _____

CITY _____ PROVINCE OR STATE _____ POSTAL CODE OR ZIP CODE _____

TEL. _____ E-MAIL _____

DATE PURCHASED _____ STORE _____
DD MM YY

CITY _____ PROVINCE OR STATE _____ Laguna Filter Falls (PT-1770) Laguna Skimmer Filter (PT-1774)

In order to help us serve you better, please complete and mail this Registration Card to: CANADA: Rolf C. Hagen Inc. 3225, rue Sartelon Montréal (Québec) H4R 1E8 U.S.A.: Rolf C. Hagen (USA) Corp., 305 Forbes Blvd. Mansfield, MA 02048-1892 U.S.A. Or, if you prefer, you may register on our web site (www.hagen.com).

WARRANTY Laguna Filter Falls and Skimmer Filter are guaranteed against defects in material or workmanship for a period of 1 year from date of purchase, under normal usage. The unit will be repaired or replaced at the manufacturer's discretion, free of charge. This warranty does not apply to any units that have been subjected to misuse, negligence, tampering or accidental damage. No liability is assumed with respect to loss or damage to livestock or personal property irrespective of the cause thereof. This warranty does not affect your statutory rights. This warranty does not cover Filter Media.



POWERFLO

SKIMMER FILTER

FILTER FALLS

5000

Service

If you have a problem or question about the operation of this product, please let us try to help you before you return the product. Most problems can be handled promptly over the phone. When you call, please have all relevant information, such as model number and/or part numbers.

Call our Customer Service Department:

CANADA ONLY: Toll Free Number 1-800-55HAGEN (1-800-554-2436) Between 9:00 AM and 5:00 PM Eastern Time.

U.S. ONLY: Toll Free Number 1-800-724-2436 Between 9:00 AM and 4:00 PM Eastern Time.

AUTHORIZED WARRANTY REPAIR SERVICE

If this product is defective, return it along with proof of purchase to either the store where you bought it or to:

CANADA: Rolf C. Hagen Inc.,
3225 Sartelon St., Montreal, Quebec H4R 1E8

US: Rolf C. Hagen (USA) Corp., 305 Forbes Blvd. Mansfield, MA 02048-1892

For general information on our whole product range, explore our website at: www.hagen.com

PRINTED IN CANADA

Distributed by:

CANADA: ROLF C. HAGEN INC.
3225 Sartelon St., Montreal, Quebec, Canada H4R 1E8
USA: ROLF C. HAGEN (USA) CORP.
Mansfield, MA. 02048, USA